

## Han<sup>®</sup>-Terminal Block Connectors

Page

Details of the Han <sup>®</sup> -Terminal block connector .....	<b>08.02</b>
Han D <sup>®</sup> AV .....	<b>08.10</b>
Han D <sup>®</sup> AV Distributor .....	<b>08.12</b>
Han E <sup>®</sup> AV .....	<b>08.14</b>
Han <sup>®</sup> ES AV .....	<b>08.16</b>
Han <sup>®</sup> -Terminal block connectors accessories .....	<b>08.17</b>

Han  
AV

Mounting example

Terminal block connector Han D® AV with mountable distributor

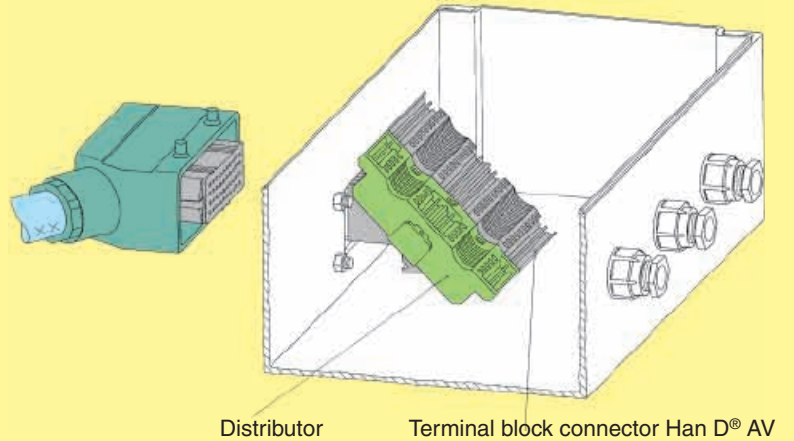

Possibilities in switch cabinet

Left or right hand mounting in the switch cabinet, therefore allows use of the same pre-prepared interface cable.

Internal use on standard rails in the switch cabinet in conjunction with Han-Snap®.

Distributor lockable on standard rails or mountable at terminal block connector Han D® AV

The terminal block connectors can be supplied for left hand or right hand applications. Hence the ground and connecting terminal for contact no. 1 will always be accessible from above in both types of installation.

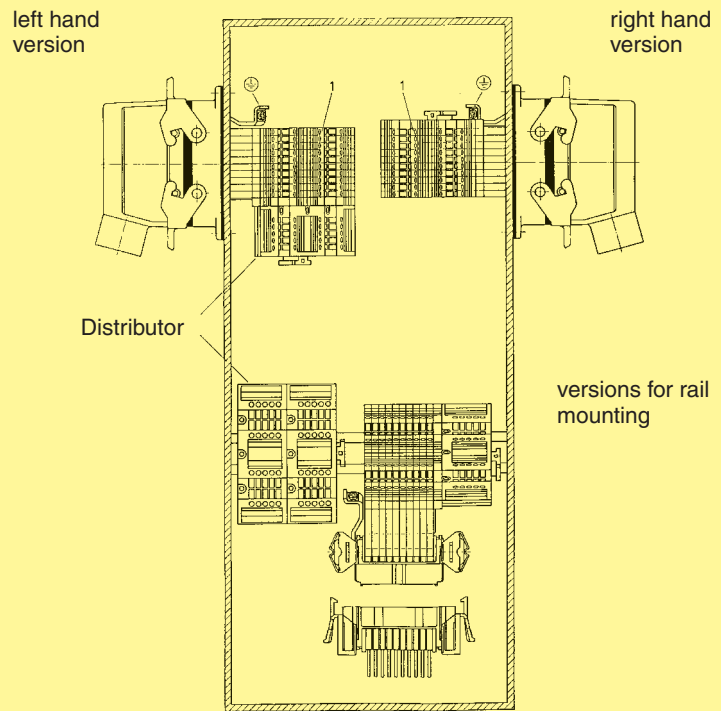

Assembly of terminal block connectors

Terminal block connectors can be mounted from the inside of the switch cabinet into standard bulkhead housings. Therefore pre-assembly is possible.

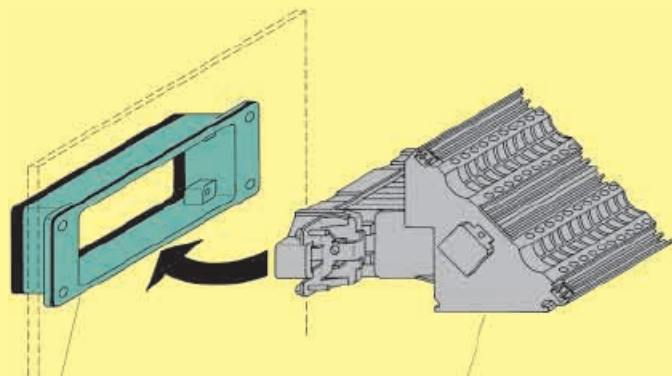

Standard bulkhead housing

Terminal block connector

Han AV

Possibilities in switch cabinet

Left or right hand mounting in the switch cabinet, therefore allows use of the same pre-prepared interface cable.

Internal use on standard rails in the switch cabinet in conjunction with Han-Snap®.

The terminal block connectors can be supplied for left hand or right hand applications. Hence the ground and connecting terminal for contact no. 1 will always be accessible from above in both types of installation.

left hand version

right hand version

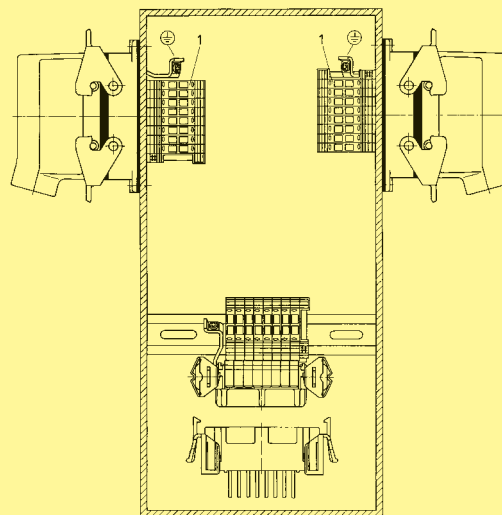

version for rail mounting

Han AV

Assembly of terminal block connector

The terminal block connector is fixed in the standard bulkhead housing in the normal way.

Han E® AV and Han® ES AV with 16 and 24 pins can be mounted from the inside of the switch cabinet into standard bulkhead housings. Therefore pre-assembly is possible.

Male or female insert

housing (bulkhead mounting)

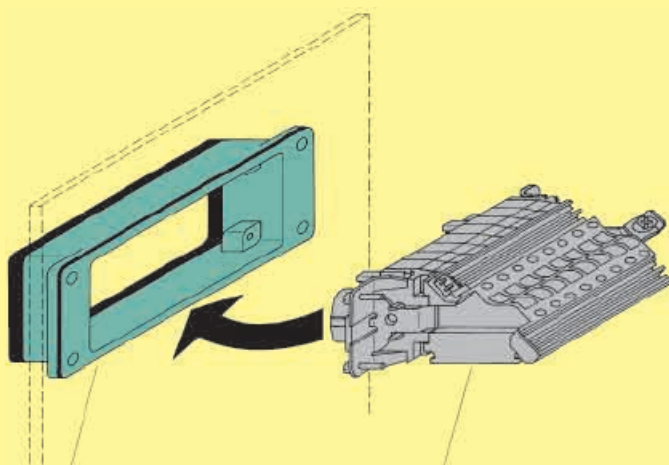
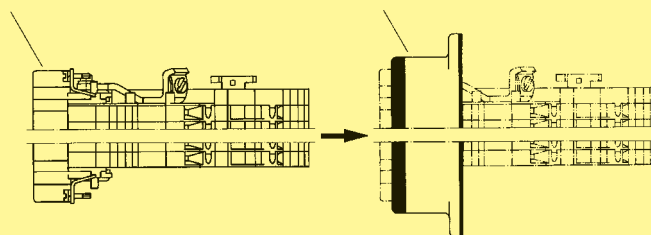

Standard housing (bulkhead mounting) Terminal block connector Han E® AV

Counterparts

For suitable mating inserts with screw, cage-clamp or crimp terminals, hoods and bulkhead housings please refer to the chapter 03.

Specifications

DIN VDE 0627  
DIN VDE 0110  
DIN EN 61 984

Approvals



Inserts

Number of contacts 40, 64 + PE

Electrical data  
acc. to DIN EN 61 984

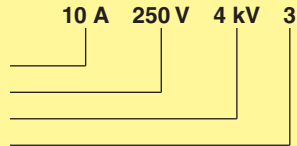

Working current  
Working voltage  
Rated impulse voltage  
Pollution degree

– Pollution degree 2 also 10 A 230/400 V 4 kV 2

Working voltage  
acc. to UL/CSA 600 V

Insulation resistance  $\geq 10^{10} \Omega$   
Material Polycarbonate  
Limiting temperatures  $-40^{\circ}\text{C} / +125^{\circ}\text{C}$   
Flammability acc. to UL 94 V0  
Mechanical working life  
– Mating cycles  $\geq 500$

Contacts

Material copper alloy  
Surface  
– mating side 3  $\mu\text{m}$  Ag  
– termination side tin plated  
Contact resistance  $\leq 4 \text{ m}\Omega$

Screw terminal  
– mm<sup>2</sup> 0.2-2.5 mm<sup>2</sup>  
– AWG 24-14  
– Tightening/test torque 0.5 Nm

Hoods/Housings

Material die cast aluminium  
Surface powder-coated RAL 7037  
Locking elements Han-Easy Lock<sup>®</sup>  
Hoods/Housings seal NBR  
Limiting temperatures  $-40^{\circ}\text{C} / +125^{\circ}\text{C}$   
Degree of protection acc. to DIN EN 60 529 for coupled connector IP 65

Identification strips

Multi contour (MK)  
the following identification strips may be used  
● HARTING – 09 21 000 9971  
● Murrplastik – KPX 5/10-5  
● Weidmüller – dekafix 5  
● Phoenix – 4 K – DST 5  
● Phoenix – DS 5  
● Phoenix – RBS 5  
● Phoenix – ZB 5  
● WAGO – WSB 5

Single contour (SK)  
the following identification strips may be used  
● Murrplastik – KWI 5/10  
● Murrplastik – KWI 5/10-5  
● Murrplastik – KWI 8.6-5  
● Wieland – 9705 A 5/10  
● WAGO – Mini - WSB

Current carrying capacity

The current carrying capacity is limited by maximum temperature of materials for inserts and contacts including terminals. The current capacity-curve is valid for continuous, not interrupted current-loaded contacts of connectors when simultaneous power on all contacts is given, without exceeding the maximum temperature.

Control and test procedures according to DIN IEC 60 5 12-5.

Han 40 D<sup>®</sup> AV

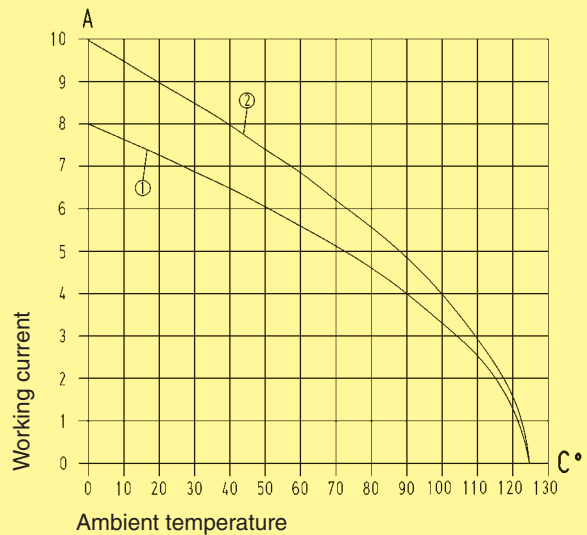

Han 64 D<sup>®</sup> AV

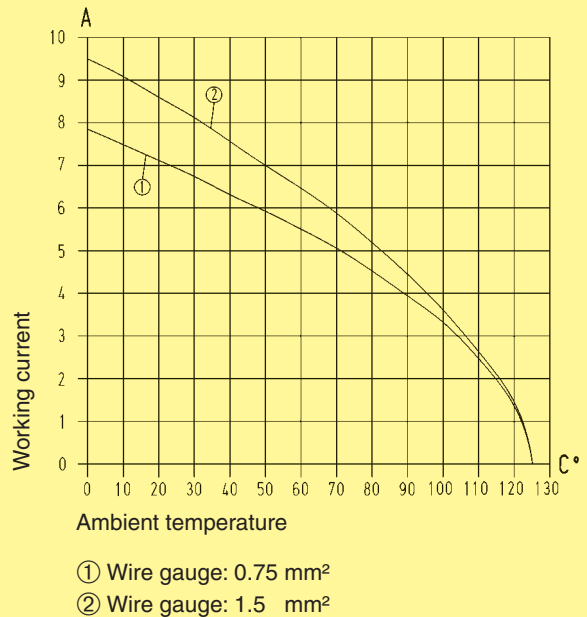

Identification

The individual terminals have the same identification as on the mating face. In addition each circuit may be separately labelled with identification strips fitted in the adjacent slots.

Han AV

Number of contacts

40, 64 +



Terminal block connectors

Identification	Number of contacts	Male insert	Female insert	Part No.	Drawing	Dimensions in mm
Left hand version Multi contour (MK)	40	<b>09 21 040 4601</b>	<b>09 21 040 4701</b>			
	64	<b>09 21 064 4601</b>	<b>09 21 064 4701</b>			
Left hand version Single contour (SK)	40	09 21 040 4602	09 21 040 4702			
	64	09 21 064 4602	09 21 064 4702			
Right hand version Multi contour (MK)	40	<b>09 21 040 4611</b>	<b>09 21 040 4711</b>			
	64	<b>09 21 064 4611</b>	<b>09 21 064 4711</b>			
Right hand version Single contour (SK)	40	09 21 040 4612	09 21 040 4712			
	64	09 21 064 4612	09 21 064 4712			

	a	b
Han <sup>®</sup> 40 D	51	77.5
Han <sup>®</sup> 64 D	81.5	104

Han AV

## Specifications

DIN VDE 0627  
DIN VDE 0110  
DIN EN 61 984

## Approvals



## Distributor

Number of contacts	20, 2 x 10, 4 x 4
Electrical data acc. to DIN EN 61 984	<b>16 A 400/690 V 6 kV 3</b>
Working current	_____
Working voltage	_____
Rated impulse voltage	_____
Pollution degree	_____
- Pollution degree 2 also	16 A 480/830 V 6 kV 2
Working voltage acc. to UL/CSA	600 V
Insulation resistance	≥ 10 <sup>10</sup> Ω
Material	Polycarbonate
Limiting temperatures	- 40 °C / +125 °C
Flammability acc. to UL 94	V0
Mechanical working life	≥ 500
- Mating cycles	

## Contacts

Material	copper alloy
Surface	
- termination side	tin plated
Screw terminal	
- mm <sup>2</sup>	0.2-2.5 mm <sup>2</sup>
- AWG	24-14
- Tightening/test torque	0.5 Nm

## Identification strips

- the following identification strips may be used
- HARTING – 09 21 000 9971
  - Murrplastik – KPX 5/10-5
  - Phoenix – 4 K – DST 5
  - Phoenix – RBS 5
  - Phoenix – ZB 5
  - Phoenix – DS 5

## Mounting example

Distributor  
on standard rail

Distributor  
with terminal block connector  
Han D<sup>®</sup>

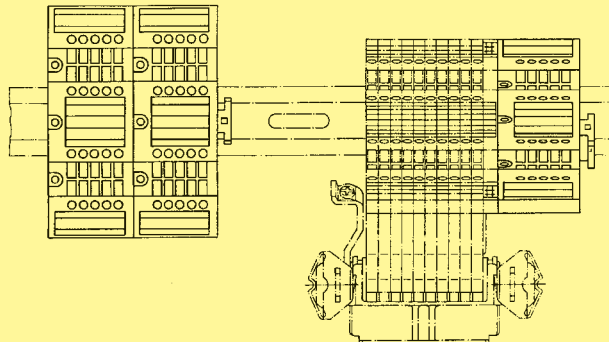

## Identification

The individual terminals have the same identification as on the mating face.  
In addition each circuit may be separately labelled with identification strips fitted in the adjacent slots.

Terminals

20



Distributors

Identification	Terminals	Part No.	Drawing	Dimensions in mm
Distributor with screw terminals	20	09 42 020 0111		<p>Optionally mountable on terminal block connectors Han D® AV</p>
	2 x 10	<b>09 42 020 0121</b>		
	4 x 4	09 42 020 0131		

Han AV

Specifications

DIN VDE 0627  
DIN VDE 0110  
DIN EN 61 984

Approvals



Inserts

Number of contacts 6, 10, 16, 24, 32 (2 x 16),  
48 (2 x 24) + PE

Electrical data  
acc. to DIN VDE 0627

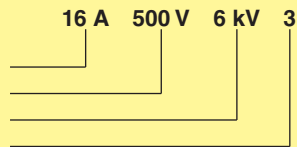

Working current  
Working voltage  
Rated impulse voltage  
Pollution degree

– Pollution degree 2 also 16 A 400/690 V 6 kV 2

Working voltage  
acc. to UL/CSA 600 V  
Working current acc. to CSA 12 A (only for Han<sup>®</sup> ES)

Test voltage  $U_{rms}$  3 kV  
Insulation resistance  $\geq 10^{10} \Omega$   
Material Polycarbonate  
Limiting temperatures - 40 °C / +125 °C  
Flammability acc. to UL 94 V 0  
Mechanical working life  
- Mating cycles  $\geq 500$

Contacts

Material copper alloy  
Surface  
- mating side 3  $\mu$ m Ag  
- termination side tin plated  
Contact resistance  $\leq 4 m\Omega$

Screw terminal  
- mm<sup>2</sup> 0.2-2.5 mm<sup>2</sup>  
- AWG 24-14  
- Tightening/test torque 0.5 Nm

Cage-clamp terminal  
- Wire gauge 0.14-2.5 mm<sup>2</sup>  
- AWG 26-14

Identification strips Han E<sup>®</sup> AV

Multi contour (MK)  
the following identification strips may be used  
● HARTING 6 x 10 – 09 33 000 9971  
● Murrplastik – KPX 6 / 10  
● Weidmüller – dekafix 6.5  
● Phoenix – 4 K – DST 6  
● Phoenix – DST 6  
● WAGO – WSB

Single contour (SK)  
the following identification strips may be used  
● Murrplastik – KWI 6/10  
● Wieland – 9705 A/6.7  
● WAGO – Mini - WSB

Identification strips Han<sup>®</sup> ES AV

the following identification strips may be used  
● HARTING – 09 33 000 9973 (6 x 15)  
● Murrplastik – KWI 6/15  
● Wieland – 9705 A/6.7  
● WAGO – Mini - WSB

Current carrying capacity

The current carrying capacity is limited by maximum temperature of materials for inserts and contacts including terminals. The current capacity-curve is valid for continuous, not interrupted current-loaded contacts of connectors when simultaneous power on all contacts is given, without exceeding the maximum temperature.

Control and test procedures according to DIN IEC 605 12-5.

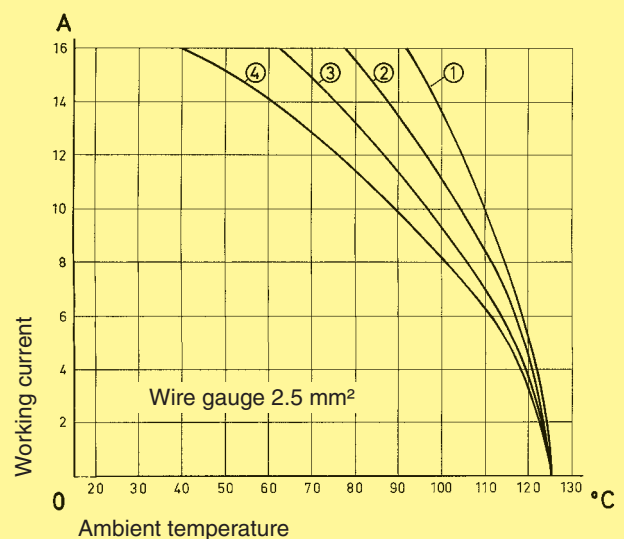
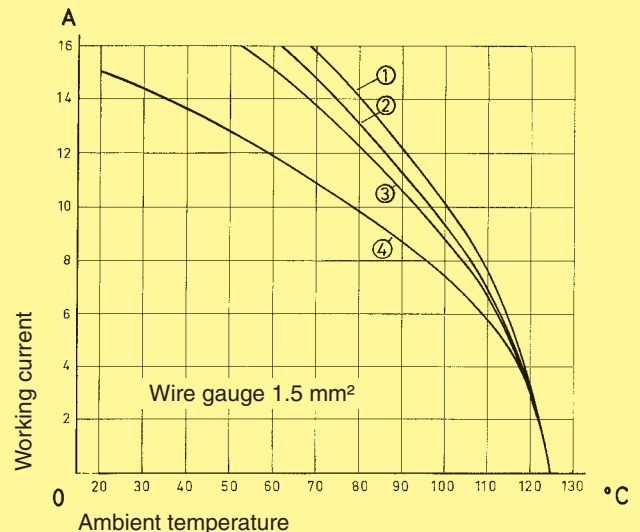

- ① Han 6 E<sup>®</sup> AV / Han<sup>®</sup> 6 ES AV
- ② Han 10 E<sup>®</sup> AV / Han<sup>®</sup> 10 ES AV
- ③ Han 16 E<sup>®</sup> AV / Han<sup>®</sup> 16 ES AV
- ④ Han 24 E<sup>®</sup> AV / Han<sup>®</sup> 24 ES AV

Identification

The individual terminals have the same identification as on the mating face.  
In addition each circuit may be separately labelled with identification strips fitted in the adjacent slots.

Number of contacts

6-24 +



Terminal block connectors

Identification	Number of contacts	Male insert	Female insert	Part No.	Drawing	Dimensions in mm
Left hand version Multi contour (MK)	6	09 33 006 4625	<b>09 33 006 4725</b>			
	10	09 33 010 4625	<b>09 33 010 4725</b>			
	16	<b>09 33 016 4625</b>	<b>09 33 016 4725</b>			
	24	<b>09 33 024 4625</b>	<b>09 33 024 4725</b>			
Left hand version Single contour (SK)	6	09 33 006 4626	09 33 006 4726			
	10	09 33 010 4626	09 33 010 4726			
	16	09 33 016 4626	09 33 016 4726			
	24	<b>09 33 024 4626</b>	<b>09 33 024 4726</b>			
Right hand version Multi contour (MK)	6	09 33 006 4635	<b>09 33 006 4735</b>			
	10	09 33 010 4635	<b>09 33 010 4735</b>			
	16	<b>09 33 016 4635</b>	<b>09 33 016 4735</b>			
	24	<b>09 33 024 4635</b>	<b>09 33 024 4735</b>			
Right hand version Single contour (SK)	6	09 33 006 4636	09 33 006 4736			
	10	09 33 010 4636	09 33 010 4736			
	16	09 33 016 4636	09 33 016 4736			
	24	09 33 024 4636	<b>09 33 024 4736</b>			

	a	b
Han® 6 E	20	44
Han® 10 E	34	57
Han® 16 E	54	77.5
Han® 24 E	81	104

Han AV

Number of contacts

6-24 +



Terminal block connectors (cage-clamp terminal)

Han AV

Identification	Number of contacts	Male insert	Female insert	Part No.	Drawing	Dimensions in mm												
Left hand version Single contour (SK)	6	09 33 006 4629	<b>09 33 006 4729</b>															
	10	09 33 010 4629	<b>09 33 010 4729</b>															
	16	<b>09 33 016 4629</b>	<b>09 33 016 4729</b>															
	24	<b>09 33 024 4629</b>	<b>09 33 024 4729</b>															
			<table border="1"> <thead> <tr> <th></th> <th>a</th> <th>b</th> </tr> </thead> <tbody> <tr> <td>Han® 6 E</td> <td>20</td> <td>44</td> </tr> <tr> <td>Han® 10 E</td> <td>34</td> <td>57</td> </tr> <tr> <td>Han® 16 E</td> <td>54</td> <td>77.5</td> </tr> <tr> <td>Han® 24 E</td> <td>81</td> <td>104</td> </tr> </tbody> </table>			a	b	Han® 6 E	20	44	Han® 10 E	34	57	Han® 16 E	54	77.5	Han® 24 E	81
	a	b																
Han® 6 E	20	44																
Han® 10 E	34	57																
Han® 16 E	54	77.5																
Han® 24 E	81	104																
Right hand version Single contour (SK)	6	09 33 006 4639	<b>09 33 006 4739</b>															
	10	09 33 010 4639	<b>09 33 010 4739</b>															
	16	09 33 016 4639	<b>09 33 016 4739</b>															
	24	<b>09 33 024 4639</b>	<b>09 33 024 4739</b>															
			<table border="1"> <thead> <tr> <th></th> <th>a</th> <th>b</th> </tr> </thead> <tbody> <tr> <td>Han® 6 E</td> <td>20</td> <td>44</td> </tr> <tr> <td>Han® 10 E</td> <td>34</td> <td>57</td> </tr> <tr> <td>Han® 16 E</td> <td>54</td> <td>77.5</td> </tr> <tr> <td>Han® 24 E</td> <td>81</td> <td>104</td> </tr> </tbody> </table>			a	b	Han® 6 E	20	44	Han® 10 E	34	57	Han® 16 E	54	77.5	Han® 24 E	81
	a	b																
Han® 6 E	20	44																
Han® 10 E	34	57																
Han® 16 E	54	77.5																
Han® 24 E	81	104																



## Fixing element

Identification	Part No.	Drawing	Dimensions in mm
<p>Fixing element for terminal block connector Han D® and distributor</p>	<p>09 33 000 9928</p>	<p>Terminal block connectors Han D®, Distributor</p> <p>Fixing element</p> <p>C-rail DIN EN 60 715-C 30</p> <p>G-rail DIN EN 60 715-G 32</p> <p>Rail DIN EN 60 715-35 x 7.5 or -35 x 15</p>	<p>20</p> <p>60</p>
<p>Fixing element for terminal block connector Han E® terminal block connector Han® ES</p>	<p>09 33 000 9929</p>	<p>Terminal block connectors Han E®</p> <p>Fixing element</p> <p>C-rail DIN EN 60 715-C 30</p> <p>G-rail DIN EN 60 715-G 32</p> <p>Rail DIN EN 60 715-35 x 7.5 or -35 x 15</p> <p>There are moulded slots at the rear of the terminal block connectors and distributors to accept the fixing elements. When used these elements, for example, can be used to secure the connectors inside the switch cabinets on standard rails.</p> <p>For mounting                      Terminal block connector Han E®/Han® ES = 1 fixing element                      Han® 6 E = 1 fixing element                      Han® 10 E, 16 E and 24 E = 2 fixing elements</p>	<p>Terminal block connector Han D® Han® 40 D, 64 D = 2 fixing elements                      Distributor = 1 fixing element</p>

Han AV

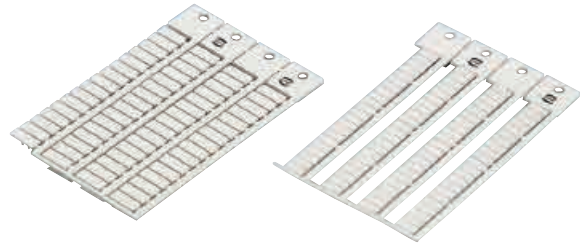

Han  
AV

Identification	Part No.	Drawing	Dimensions in mm										
<b>Identification strips</b> 88 pieces in one block (MK-contour)  5 mm width  10 mm long	<b>09 21 000 9971</b>	fits terminal block connector Han D® AV and distributor											
<b>Identification strips</b> 64 pieces in one block (MK-contour)  6 mm width  10 mm long  15 mm long	<b>09 33 000 9971</b>  <b>09 33 000 9973</b>	fits terminal block connector Han E® AV  fits terminal block connector Han® ES AV											
<b>Adapter for Han E® AV</b> to fit identification strips (SK-contour)  – Han 6 E® AV – Han 10 E® AV – Han 16 E® AV – Han 24 E® AV	<b>09 33 000 9964</b> <b>09 33 000 9965</b> <b>09 33 000 9966</b> <b>09 33 000 9967</b>		<table border="1"> <thead> <tr> <th></th> <th>a</th> </tr> </thead> <tbody> <tr> <td>Han 6 E® AV</td> <td>26.8</td> </tr> <tr> <td>Han 10 E® AV</td> <td>40.2</td> </tr> <tr> <td>Han 16 E® AV</td> <td>60.3</td> </tr> <tr> <td>Han 24 E® AV</td> <td>87.4</td> </tr> </tbody> </table>		a	Han 6 E® AV	26.8	Han 10 E® AV	40.2	Han 16 E® AV	60.3	Han 24 E® AV	87.4
	a												
Han 6 E® AV	26.8												
Han 10 E® AV	40.2												
Han 16 E® AV	60.3												
Han 24 E® AV	87.4												